

6000/6500 SERIES



The Clearview PVC series patio doors are made of high quality extruded vinyl, and manufactured to suit Clearview's quality and craftsmanship. They offer exceptional strength, rigidity, and tolerance, while maintaining superior insulating values.



CLEARVIEW

PATIO DOORS

Clearly The Right Choice

Patio Door Design Features

Standard Features - 6000 series:

- Extruded PVC vinyl frame best resists the transfer of heat and cold, and will not warp, split, or rot.
- The stiles are reinforced with aluminum or steel for strength.
- Full perimeter, double weatherstrip eliminates water and air infiltration.
- Two tandem steel rollers provide years of quiet, smooth operation.
- Aluminum screen with fiberglass mesh, and four adjustable steel rollers.
- Complete with durable surface mounted lock.
- Sill is sloped to ease water run off.
- Fully reversible, can be assembled to slide left or right.
- Tempered glass, clear on LowE 1" Warm Edge sealed units.



6' x 8' Colonial Grill LowE Argon 3"x5" pattern.



Patio door with adjustable built in mini-blinds. (only available in the 6500 series)

Standard Features - 6500 series:

- Wood with vinyl clad frame system offers all the 6000 series features but with additional frame rigidity. Wood frame allows for casing to be easily nailed to door frame.

Optional Features:

Clearview's glass options:

- Clear glass
- Bronze/Grey glass
- V-groove glass
- Mini-Blinds

Other available options:

- Heavy duty aluminum screen mesh
- Transom or sidelites
- Sidelites (offered only with 6500 series)
- Sill extensions
- Vinyl jamb extensions - 1¹/₄"
- Wood jamb extensions - 2"
- Brick mould - 1"
- Nailing fin
- Pet mesh

Clearview specializes in custom orders.



9' door, centre operator, with pewter pencil, prairie grill pattern, pewter finish mortise lock.

Decorative Grill Bar / Spacer Bar Options

Clearview Industries offers a variety of decorative grill bar options. Shown below are some of the most popular design patterns. Custom designs may be available depending on availability and order.

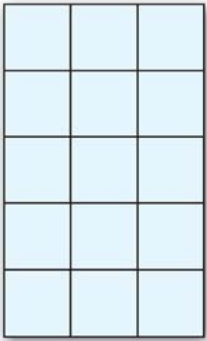

3 x 5 Colonial
(standard pattern)

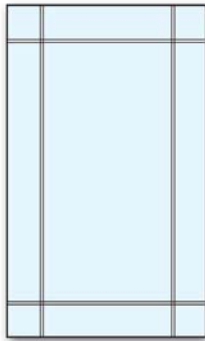

3 x 3 Prairie

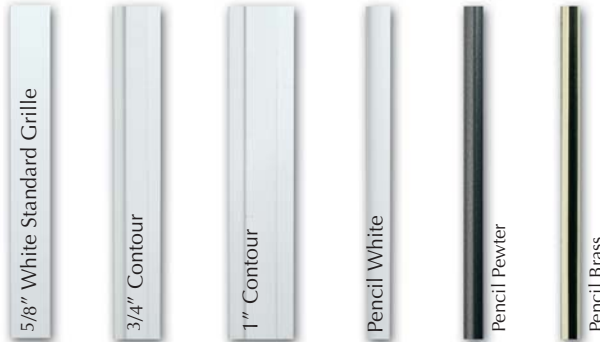

Decorative grill bar options

Available spacers:

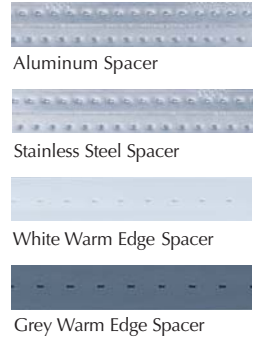

Door Handles / Security Lock Systems / Door Frame Colours

Clearview Industries offers a variety of door handles and security lock systems to choose from. Shown below are the standard door handles and security locks available with the 6000/6500 series.



White Mortise Lock
(standard)



Black Nickel Mortise Lock
(upgrade)



Brushed Chrome Mortise Handle
(upgrade)



Multipoint Lock
(upgrade)

Lock and security system options:

Security lock options.

- Security Bar
 - Foot Lock
 - Door Guardian Lock
 - Key Locks
 - Locks are available in various finishes.
- Please inquire with your sales agent.



Foot Lock



Security Bar



Door Guardian Lock

Colours (colours are approximate, variations may occur)
(custom colours are available)



White 137



White 143



Cream



Maize



Cashmere



Driftwood



Pebble



Sandalwood



Commercial



Chocolate



Black

6000 series top view (all vinyl frame)

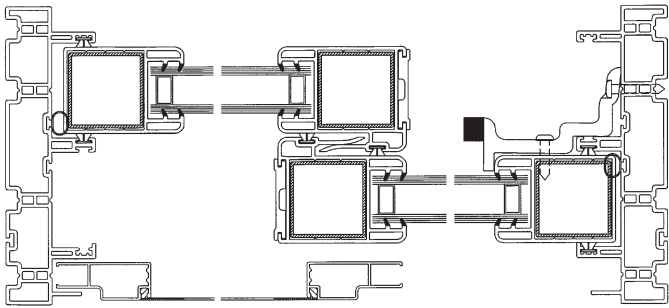

6500 series top view (vinyl clad wood buck frame)

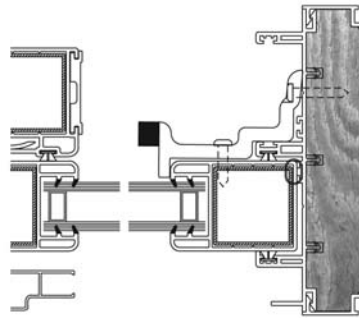

Performance Ratings:

	STD	HP
Air Infiltration:	A3	A3
Water Infiltration:	B2	B2
Windload Resistance:	C2	C3
Ease of Operation:	E3	E3
Forced Entry:	F2	F2
Temperature Index:	I57	I57
Energy Star ratings:		
All zones.(6000 series only)		

6000/6500 series technical specifications:

Canadian Sizes – 6000/6500 series (Frame depth 5⁵/₈, comes with screen)

SIZE	Frame Size (in.)		Exterior View Rough Opening (in.)	
	6000 Series Width	6000 Series Height	6500 Series Width	6500 Series Height
5068	59 ⁵ / ₈ x 79 ¹ / ₂ (94 ¹ / ₄)	59 ⁵ / ₈ x 79 ³ / ₄ (94 ¹ / ₂)	XO or OX	60 ¹ / ₄ x 80 (95)
6068	71 ⁵ / ₈ x 79 ¹ / ₂ (94 ¹ / ₄)	71 ⁵ / ₈ x 79 ³ / ₄ (94 ¹ / ₂)	XO or OX	72 ¹ / ₄ x 80 (95)
8068	95 ⁵ / ₈ x 79 ¹ / ₂ (94 ¹ / ₄)	95 ⁵ / ₈ x 79 ³ / ₄ (94 ¹ / ₂)	XO or OX	96 ¹ / ₄ x 80 (95)
7668	87 ¹ / ₂ x 79 ¹ / ₂ (94 ¹ / ₄)	86 ⁷ / ₈ x 79 ³ / ₄ (94 ¹ / ₂)	XOO or OOX	88 ¹ / ₄ x 80 (95)
7668	89 ¹ / ₄ x 79 ¹ / ₂ (94 ¹ / ₄)	89 ¹ / ₄ x 79 ³ / ₄ (94 ¹ / ₂)	O X O	90 x 80 (95)
9068	107 ¹ / ₄ x 79 ¹ / ₂ (94 ¹ / ₄)	107 ¹ / ₄ x 79 ³ / ₄ (94 ¹ / ₂)	O X O	108 x 80 (95)
9068	105 ¹ / ₂ x 79 ¹ / ₂ (94 ¹ / ₄)	104 ⁷ / ₈ x 79 ³ / ₄ (94 ¹ / ₂)	XOO or OOX	106 ¹ / ₄ x 80 (95)
10068	118 ³ / ₈ x 79 ¹ / ₂ (94 ¹ / ₄)	117 ³ / ₄ x 79 ³ / ₄ (94 ¹ / ₂)	O XX O	119 x 80 (95)
12068	143 ¹ / ₄ x 79 ¹ / ₂ (94 ¹ / ₄)	143 ¹ / ₄ x 79 ³ / ₄ (94 ¹ / ₂)	O X O	144 x 80 (95)
12068	144 ¹ / ₂ x 79 ¹ / ₂ (94 ¹ / ₄)	143 ⁷ / ₈ x 79 ³ / ₄ (94 ¹ / ₂)	XOO or OOX	145 ¹ / ₄ x 80 (95)
12068	142 ³ / ₈ x 79 ¹ / ₂ (94 ¹ / ₄)	141 ³ / ₄ x 79 ³ / ₄ (94 ¹ / ₂)	O XX O	143 x 80 (95)
16068	190 ³ / ₈ x 79 ¹ / ₂ (94 ¹ / ₄)	189 ³ / ₄ x 79 ³ / ₄ (94 ¹ / ₂)	O XX O	191 x 80 (95)

Standard glass sizes (in.)

(Custom glass sizes available)

26 ¹ / ₂ x 70 ⁷ / ₈ (85 ³ / ₄)	5' door
32 ¹ / ₂ x 70 ⁷ / ₈ (85 ³ / ₄)	6' door
44 ¹ / ₂ x 70 ⁷ / ₈ (85 ³ / ₄)	8' door

Standard Screen Sizes (in.)

(Custom screens available)

30 x 77 ¹ / ₈	5' door
36 x 77 ¹ / ₈	6' door
48 x 77 ¹ / ₈	8' door

U.S. Sizes – 6000

Size Frame Size (in.)

5068 58⁵/₈ x 79¹/₂

6068 70⁵/₈ x 79¹/₂

Exterior View Rough Opening (in.)

5068 XO or OX 59 x 80

6068 XO or OX 71 x 80

Mini-blind door sizes for 6500 series only:

5' 58⁷/₈ x 79¹/₄ 6' 70⁷/₈ x 79¹/₄

Configuration: X = Operator, O = Fixed



Left: Cross section of 6000 series patio door. Door frames are extruded vinyl, weather resistant and maintenance free.



Performance ratings meet or exceed the specifications of CAN/CGSB-82 1-M89.

Left: Cross section of 6500 series patio door features vinyl clad wood buck frame.



Sill Extension



2" Wood Extension

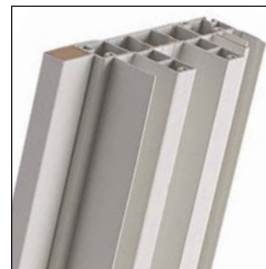

1 1/4" Vinyl Extension



1" Brick Mould

Notice: Due to Clearview's continuous product development, specifications are subject to change without notice. Please contact an authorized dealer or Clearview Industries Ltd. to confirm the most recent specifications.

Authorized Distributor:



10 Year Limited Warranty on Insulating Glass Units.

10 Year Limited Warranty on Vinyl Components.

2 Year Limited Warranty on Hardware.

CLEARVIEW

Member: BILD, CRVA, NFRC

www.clearview.on.ca

e-mail: sales@clearview.on.ca